



**Raccordi per saldatura nel
bicchiere in PP-H**

PP-H socket fusion fittings

**Raccords pour soudure dans
l'emboîture en PP-H**

**Formteile zum Heizelementmuffen-
schweißen aus PP-H**

PP-H



I dati del presente prospetto sono forniti in buona fede. La FIP non si assume alcuna responsabilità su quei dati non direttamente derivati da norme internazionali. La FIP si riserva di apportarvi qualsiasi modifica.

The data given in this leaflet are offered in good faith. No liability can be accepted concerning technical data that are not directly covered by recognized international standards. FIP reserves the right to carry out any modification to the products shown in this leaflet.

Les données contenues dans cette brochure sont fournies en bonne foi. FIP n'assume aucune responsabilité pour les données qui ne dérivent pas directement des normes internationales. FIP garde le droit d'apporter toute modification aux produits présentés dans cette brochure.

Alle Daten dieser Druckschrift wurden nach bestem Wissen angegeben, jedoch besteht keine Verbindlichkeit, sofern sie nicht direkt internationalen Normen entnommen wurden. Die Änderung von Maßen oder Ausführungen bleibt FIP vorbehalten.

Raccordi per saldatura nel bicchiere in PP-H

- Gamma dimensionale da d 20 mm a d 110 mm.
- Materiale: polipropilene PP-H
- Resistenza a pressioni di esercizio fino a 10 bar a 20°C
- Temperatura massima di esercizio: 100 °C.
- Sistema di giunzione: saldatura nel bicchiere o filettatura.
- Per maggiori informazioni visita il sito: www.fipnet.it.

PP-H socket fusion fittings

- Size range: from d 20 mm up to d 110 mm.
- Material: polypropylene PP-H
- Maximum working pressure: 10 bar at 20°C
- Maximum working temperature: 100 °C.
- Jointing by socket fusion technique or threaded connections.
- For more information please visit our website: www.fipnet.it.

Raccords pour souder dans l'emboîture en PP-H

- Gamme dimensionnelle de d 20 mm à d 110 mm.
- Matériau: polypropylène PP-H
- Pression de service jusqu'à 10 bar à 20°C
- Température de service jusqu'à 100 °C.
- Système de jonction par soudure dans l'emboîture aussi bien que par filetage.
- Pour avoir d'autres informations, visiter le site: www.fipnet.it.

Formteile zum Heizelementmuffenschweißen aus PP-H

- Abmessungen von d 20 mm bis d 110 mm.
- Material: Polypropylen PP-H
- Zulässige Betriebsüberdruck 10 bar bei wasser 20° C.
- Max Betriebstemperatur: 100 °C.
- Verbindung durch Heizelementmuffenschweißen oder Gewinde.
- Für weitere Details schauen Sie auf unsere Website: www.fipnet.it.

Legenda

d	diametro nominale esterno del tubo in mm	d	nominal outside diameter of the pipe in mm	d	diamètre extérieur nominal du tube en mm	d	Rohraußendurchmesser, mm
DN	diametro nominale interno in mm	DN	nominal internal diameter in mm	DN	diamètre nominal intérieur en mm	DN	Nennweite, mm
R	dimensione nominale della filettatura in pollici	R	nominal size of the thread in inches	R	dimension nominale du filetage en pouces	R	Gewinde in Inches
PN	pressione nominale in bar (pressione max di esercizio a 20°C in acqua)	PN	nominal pressure in bar (max. working pressure at 20° C - water)	PN	pression nominale en bar (pression de service max à 20° C - eau)	PN	Nenndruck; höchstzulässiger Betriebsdruck in bar, bei 20° C Wasser
g	peso in grammi	g	weight in grams	g	poids en grammes	g	Gewicht in Gramm
n	numero di fori	n	number of holes	n	nombre de trous	n	Lochzahl
M	bulloni	M	bolts	M	boulons	M	Schrauben (metrisches Gewinde)
C	codice di riferimento O-ring	C	O-ring code	C	codification joint	C	Kode O-Ring
PP-H	polipropilene omopolimero-MRS-10	PP-H	homopolymer polypropylene MRS-10	PP-H	polypropylène homopolymère MRS-10	PP-H	Polypropylen Homopolymerisat MRS-10
MRS	Minimo valore garantito del carico di rottura del materiale a 20° C - acqua per 50 anni di servizio	MRS	Minimum required strenght for water at 20° C for 50 years	MRS	Tension de ropture minimale (avec de l'eau à 20°C a 50 années)	MRS	Erforderliche Mindestfestigkeit bei Wasser 20°C - 50 Jahre
FPM (FKM)	fluoroelastomero	FPM (FKM)	vinylidene fluoride rubber	FPM (FKM)	fluorélastomère de vinylidène	FPM (FKM)	Fluor-Kautschuk
EPDM	elastomero etilene propilene	EPDM	ethylene propylene rubber	EPDM	élastomère éthylène-propylène	EPDM	Ethylen-Propylen-Kautschuk

**Dati
Tecnici**

**Technical
Data**

**Données
Techniques**

**Technische
Daten**

1

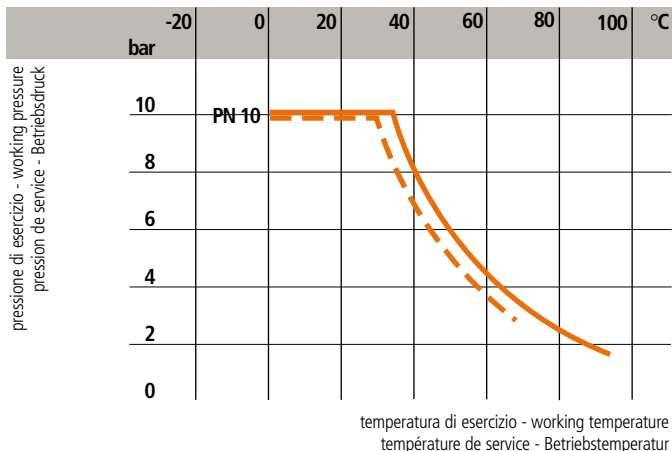

1

Variatione della pressione in funzione della temperatura per acqua o fluidi non pericolosi nei confronti dei quali il PP è classificato CHIMICAMENTE RESISTENTE. Vedere il prospetto "Guida alla resistenza chimica". In altri casi è richiesta un'adeguata diminuzione della pressione nominale PN.
 —— 10 anni - - - - 50 anni

Pressure/temperature rating for water and harmless fluids to which PP is RESISTANT. See "A guide to chemical resistance". In other cases a reduction of the rated PN is required.
 —— 10 years - - - - 50 years

Variation de la pression en fonction de la température pour l'eau et les fluides non agressifs pour lequel le PP est considéré CHIMIQUEMENT RESISTANT. Voir "Guide de résistance chimique". Pour les autres cas une diminution du PN est nécessaire.
 —— 10 années - - - - 50 années

Druck/Temperatur Diagramm für Wasser und ungefährliche Medien wogegen die PP beständig ist (siehe Beständigkeitsliste). In allen anderen Fällen ist eine Reduzierung der Druckstufe erforderlich.
 —— 10 Jahre - - - - 50 Jahre

Dimensioni

La FIP ha approntato una gamma completa di raccordi (tipo B) in accordo con le seguenti norme:

- saldatura nel bicchiere: UNI 11318 DIN 16962, accoppiabili con tubi secondo le norme: DIN 8077, UNI 8318, EN ISO 15494
- filettatura: UNI ISO 228/1, DIN 2999, BS 21.

Dimensions

FIP produces a complete range of fittings (type B) according to the following standards:

- polyfusion sockets: UNI 11318 DIN 16962, coupling to pipes complying with: DIN 8077, UNI 8318, EN ISO 15494
- threaded coupling: UNI ISO 228/1, DIN 2999, BS 21.

Dimensions

FIP à réalisé une gamme complète de raccords (type B) conformes aux normes suivantes:

- soudure suivant la UNI 11318 DIN 16962, qui peuvent être soudés avec des tubes conformes aux normes: DIN 8077, UNI 8318, EN ISO 15494
- filetage: UNI ISO 228/1, DIN 2999, BS 21.

Dimensionen

FIP produziert ein komplettes Programm Formstücke (Type B) welcher folgenden Normen entspricht:

- Schweißanschlüsse: UNI 11318 DIN 16962, für die Verbindung mit Röhren nach: DIN 8077, UNI 8318, EN ISO 15494
- Gewindeanschlüsse: UNI ISO 228/1, DIN 2999, BS 21.

GIM

GOMITO A 90°
per saldatura nel bicchiere

90° ELBOW
for socket fusion

COUDE À 90°
femelle à souder

WINKEL 90°
für Muffenschweißung
27.010.01

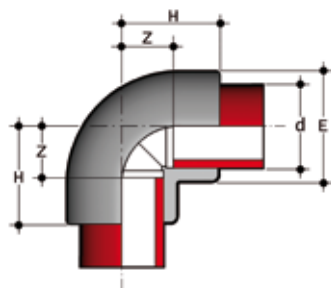

d	E	H	Z	g
20	27,5	27,5	13	14
25	33,5	32	16	23
32	41,5	37	20	37
40	51,5	42,5	22	64
50	63,5	51	27,5	105
63	78,5	61	33,5	180
75	92,5	73	42	300
90	110,5	84,5	49	455
110	135	100,5	59	815

HIM

GOMITO A 45°
per saldatura nel bicchiere

45° ELBOW
for socket fusion

COUDE À 45°
femelle à souder

WINKEL 45°
für Muffenschweißung
27.015.01

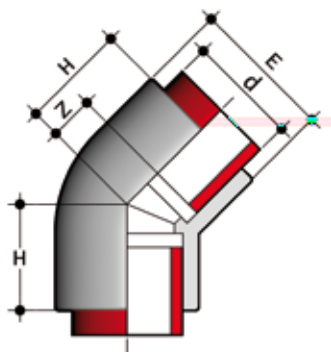

d	E	H	Z	g
20	27,5	21	6,5	12
25	33,5	24,5	8,5	19
32	42	29	12	33
40	51,5	35,5	15	57
50	63	42,5	19	105
63	79	51	23,5	182
75	92	71	38,5	240
90	113	83	46	420
110	135	98	56	660

RIM

RIDUZIONE
per saldatura nel bicchiere
d maschio, d₁ ridotto femmina

REDUCING PIECE
for socket fusion, d male, d₁
reduced female

REDUCTION
mâle à souder sur le 1^{er} d femelle à
souder sur le d₁ réduit

REDUZIERSTÜCK
für Muffenschweißung,
d Aussengewinde,
d₁ Innengewinde reduziert
27.091.03

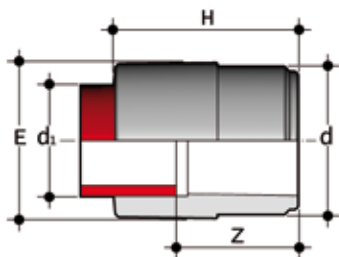

d x d ₁	E	H	Z	g
25 x 20	28	39	24,5	10
32 x 20	35,5	43	30	13
32 x 25	33,5	46	30	17
40 x 25	42	48	33	24
40 x 32	42	51	33	27
50 x 32	51,5	54	36	39
50 x 40	51,5	56,5	36	44
63 x 32	65	61	44	69
63 x 50	65	67,5	44	76
75 x 50	77,5	69	47	106
75 x 63	77,5	74,5	47	115
90 x 63	91,5	82	56	156
90 x 75	91,5	87,5	56	175
110 x 63	111,5	93	66	290
110 x 90	111,5	101,5	66	305

TIM

TI A 90°
per saldatura nel bicchiere

90° TEE
for socket fusion

TE À 90°
femelles à souder

T-STÜCK 90°
für Muffenschweißung
27.020.01

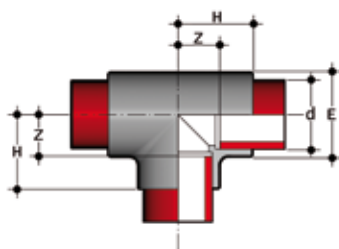

d	E	H	Z	g
20	27,5	27,5	13	19
25	33,5	31,5	15,5	30
32	41,5	37	19	47
40	52	43	22,5	80
50	64	52	28,5	145
63	79,5	62,5	35	250
75	92,5	71	40	370
90	110,5	81,5	46	560
110	134,5	99,5	58	990

BIM

BOCCHETTONE
per saldatura nel bicchiere
con guarnizione in FPM o EPDM

SOCKET UNION
for socket fusion
with FPM or EPDM gaskets

UNION
à souder
avec joint FPM ou EPDM

VERSCHRAUBUNG
für Muffenschweißung
O-Ring aus Viton FPM/EPDM
27.051.01 EPDM
27.052.01 FPM

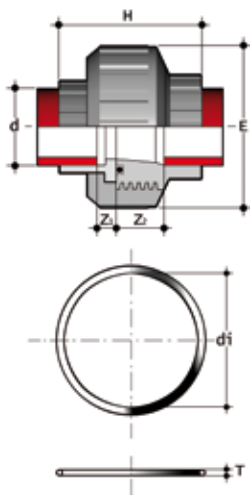

d	E	H	Z ₁	Z ₂	g
20	52	52,5	6,9	16,5	53
25	62	56,5	7,2	17,2	75
32	70	61	7,5	17,5	110
40	82	70	7,6	20,6	160
50	90,5	76,5	7,7	21,4	205
63	106	85,5	7,9	22,3	305

C	di	O-Ring
		T
4081	20,22	3,53
4112	28,17	3,53
4131	32,93	3,53
6162	40,65	5,34
6187	47	5,34
6237	59,6	5,34

BIFM

BOCCHETTONE
con una estremità per saldatura
nel bicchiere e l'altra con filettatura
cilindrica con guarnizione in FPM o
EPDM

SOCKET UNION
one end plain for socket fusion, the
other one parallel threaded with FPM
or EPDM gasket

UNION
à souder sur d, et taraudés sur R, pas
du gaz cylindrique avec joint FPM
ou EPDM

VERSCHRAUBUNG
Einlegeteil für Muffenschweißung,
Einschraubteil mit Gewindemuffe,
O-Ring aus Viton FPM/EPDM
27.051.32 EPDM
27.052.32 FPM

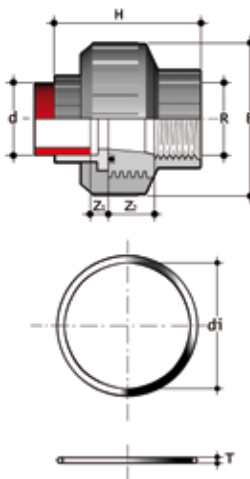

d x R	E	H	Z ₁	Z ₂	g
20 x 1/2"	52	52,2	6,9	16,5	51
25 x 3/4"	61,5	56	7,2	17,2	75
32 x 1"	70	61	7,5	17,5	115
40 x 1 1/4"	82	69	7,6	20,6	155
50 x 1 1/2"	90,5	77	7,7	21,4	210
63 x 2"	106	85,5	7,9	22,3	310

C	di	O-Ring
		T
4081	20,22	3,53
4112	28,17	3,53
4131	32,93	3,53
6162	40,65	5,34
6187	47	5,34
6237	59,6	5,34

BIFMO

BOCCHETTONE DI PASSAGGIO
Ottone/PP-H
ottone filettato femmina con guarni-
zione piana in EPDM

SOCKET UNION
Brass/PP-H
brass female threaded with EPDM
flat gasket

UNION MIXTE 3 PIÈCES
Laiton/PP-H
laiton taraudée cylindrique
avec joint Plat en EPDM

ÜBERGANGSVERSCHRAUBUNG
Messing/PP-H
Messing, Rohr-Innengewinde mit
EPDM Flachdichtung
27.055.02

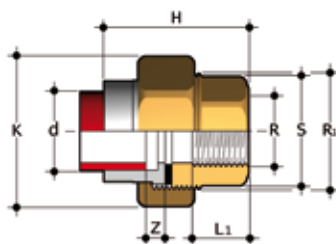

d x R	R ₁	H	Z	K	S	L ₁	g
20 x 1/2"	1"	48	6,9	37	26	15	140
25 x 3/4"	1 1/4"	53	7,2	47	32	16,3	235
32 x 1"	1 1/2"	57	7,5	54	38	19,1	270
40 x 1 1/4"	2"	63	7,6	66	47	21,4	455
50 x 1 1/2"	2 1/4"	67	7,7	72	53	21,4	510
63 x 2"	2 3/4"	74	7,9	87	67	25,7	790

BIRMO

BOCCHETTONE DI PASSAGGIO
Ottone/PP-H
ottone filettato maschio

SOCKET UNION
Brass/PP-H
brass male threaded

UNION MIXTE 3 PIÈCES
Laiton/PP-H
laiton fileté conique

ÜBERGANGSVERSCHRAUBUNG
Messing/PP-H
Messing, Rohr-Innengewinde
27.055.07

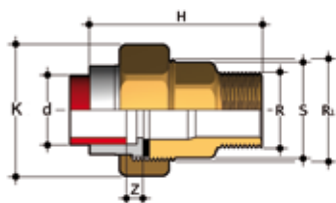

d x R	R ₁	H	Z	K	S	g
20 x 1/2"	1"	61	6,9	37	26	155
25 x 3/4"	1 1/4"	76	7,2	47	32	295
32 x 1"	1 1/2"	81	7,5	54	38	355
40 x 1 1/4"	2"	85	7,6	66	47	560
50 x 1 1/2"	2 1/4"	96	7,7	72	53	700
63 x 2"	2 3/4"	107	7,9	87	67	1035

BIMG

BOCCHETTONE
con ghiera filettata gas
guarnizione in EPDM o FPM

SOCKET UNION
with union nut BSP threaded
EPDM or FPM gasket

UNION A SOUDER
écrou pas du gaz
joint EPDM ou FPM

VERSCHRAUBUNG
mit Gewindemuffen EPDM für
Gasrohranschluß oder
FPM Runddichtring

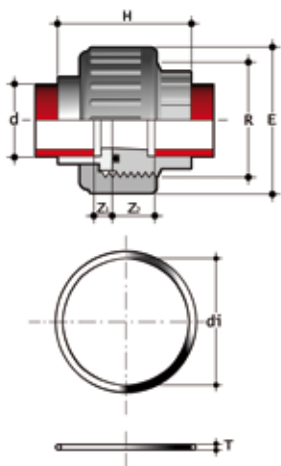

d	E	R	H	Z ₁	Z ₂	g	O-Ring		
							C	di	T
20	46	1"	52,5	6,9	16,5	40	4081	20,22	3,53
25	56	1 1/4"	56,5	7,2	17,2	60	4112	28,17	3,53
32	66	1 1/2"	61	7,5	17,5	100	4131	32,93	3,53
40	79	2"	70	7,6	20,6	140	6162	40,65	5,34
50	87	2 1/4"	76,5	7,7	21,4	215	6187	47	5,34
63	107	2 3/4"	86,5	7,9	22,3	340	6237	59,6	5,34

Q-BIMG

COLLARE D'APPOGGIO
per bocchettoni BIMG, BIRMO,
BIFMO

STUB
for socket union BIMG, BIRMO,
BIFMO

PIECE FOLLE
pour union BIMG, BIRMO, BIFMO

BUNDBUCHSE
für Verschraubung
BIMG, BIRMO, BIFMO

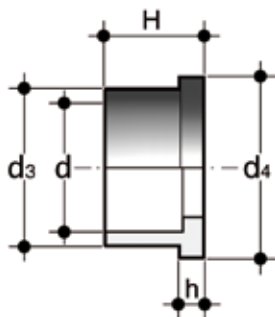

d	DN	h	d ₃	d ₄	H	g
20	15	6	27,4	30,1	21	4
25	20	6	33,9	38,7	23	11
32	25	6	41,4	44,7	25	20
40	32	6	51,7	56,3	28	27
50	40	7	58	62,6	31	40
63	50	8	73,7	78,4	35	60

EFGM

GHIERA
con filettatura gas
per bocchettoni BIMG con guarnizio-
ne piana in EPDM

UNION NUT
BSP threaded for
socket union BIMG with EPDM flat
gasket

ÉCROU
pas du gaz
pour union BIMG avec joint Plat en
EPDM

ÜBERWURFMUTTER
für Verschraubung BIMG mit EPDM
Flachdichtung

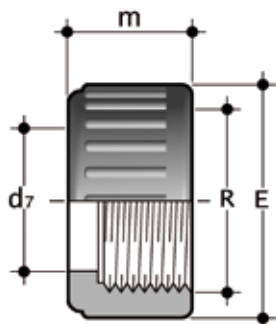

R	d ₇	m	E	g
1"	28	24	46	17
1 1/4"	36	27	56	25
1 1/2"	42	30	66	45
2"	53	32	79	61
2 1/4"	59	36	87	90
2 3/4"	74	39	107	150

AIM

PORTAGOMMA
per saldatura nel bicchiere

HOSE ADAPTOR
for socket fusion

EMBOUТ CANNEЛÉ
à souder

DRUCKSCHLAUCHTÜLLE
Schweißstutzen-Schlauchan-schluß
27.096.04

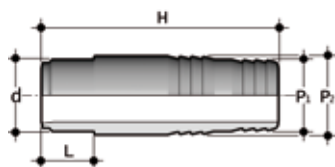

d x P ₁ x P ₂	L	H	g
20 x 22 x 20	16	67	11
25 x 27 x 25	18	81	20
32 x 32 x 30	20	95	33
40 x 42 x 40	22	104	68
50 x 52 x 50	25	111	100
63 x 64 x 60	29	122	150

MIM

MANICOTTO
per saldatura nel bicchiere

DOUBLE SOCKET
for socket fusion

MANCHON
à souder

MUFFE
für Muffenschweißung
27.091.01

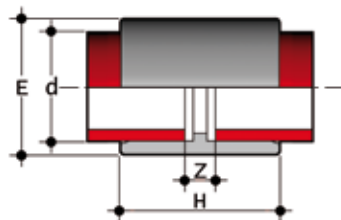

d	E	H	Z	g
20	27,8	36	7,5	10
25	33,7	39	8	16
32	42	43	8,5	25
40	51,5	47	7,5	39
50	63	55	8,2	62
63	77,5	61	9	96
75	91	70	10	145
90	108,8	80	10	230
110	132	93	12	370

MIMM

MANICOTTO
con estremità per saldatura nel
bicchiere e l'altra con filettatura
cilindrica con anello di rinforzo in
acciaio inox

SOCKET (COUPLING)
one end plain for socket fusion the
other one parallel threaded, with
reinforcing stainless steel ring

MANCHON DE PASSAGE
à souder sur d, et taraudé sur R, pas
du gaz cylindrique renforcé au taraudage en acier inox

ÜBERGANGSMUFFE
verstärkt mit Edelstahlring.
Gewindemuffe/Sweissemuffe
27.091.02

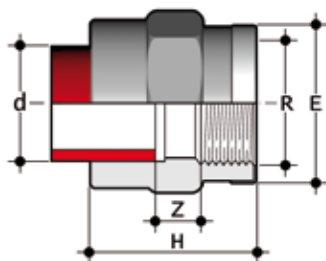

d x R	E	H	Z	g
20 x 1/2"	30	38,5	8,5	14
25 x 3/4"	39	41	8	23
32 x 1"	47	45	7	40
40 x 1 1/4"	55	50	8	46
50 x 1 1/2"	66	54,5	9	92
63 x 2"	83	63	9	150

QRNM

COLLARE D'APPOGGIO
(conforme alle norme DIN) per salda-
tura nel bicchiere a sede striata, da
impiegare con flange libere ODB

STUBFLANGE
(according to DIN norms) for socket
fusion, with serrated face, to be used
with ODB

COLLET
(conformes au normes DIN)
à souder, face striée, pour bride libre
ODB

BUNDBUCHSE gerillt
für Muffenschweißung
27.079.01

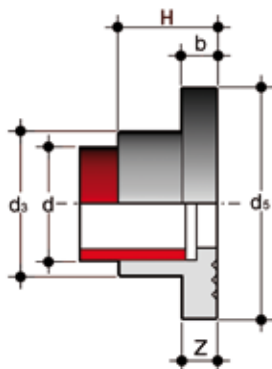

d	DN	b	d ₃	d ₅	H	Z	g
20	15	6,8	27	45	20,3	5,5	12
25	20	9	33	58	22,3	6	24
32	25	10	41	68	24,8	6,5	36
40	32	11	50	78	26,8	5,5	47
50	40	12	61	88	30	5,5	63
63	50	14	76	102	33,8	5,5	94
75	65	16	90	122	37,8	6,5	149
90	80	17	107,5	138	43,8	7,5	213
110	100	18	131	158	50	7,5	297

GRAM

COLLARE D'APPOGGIO
per saldatura nel bicchiere a sede
striata, da impiegare con flange
libere ANSI 150 (OAB). Per altre
dimensioni usare QRNM

STUBFLANGE
for socket fusion, with serrated face,
to be used with ANSI 150 backing
rings (OAB). For other dimensions
use QRNM

COLLET
à souder, face striée pour brides
libres (OAB) ANSI ISO. Pour des
autres dimensions utiliser le QRNM

BUNDBUCHSE gerillt
für ANSI 150 (OAB) Losflanschen. Für
weitere Dimensionen benutze QRNM

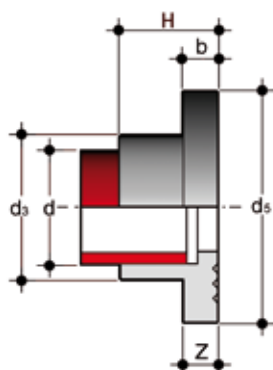

d	DN	b	d ₃	d ₅	H	Z	g
3/4"	20	9	33	54	22,3	6	24
1"	25	10	41	63,5	24,8	6,5	36
1 1/4"	32	11	50	72	26,8	5,5	47
1 1/2"	40	12	61	82,5	30	5,5	63
3"	80	17	107,5	132	43,8	7,5	213

CIM

CALOTTA
con estremità per saldatura
nel bicchiere

CAP
end plain for socket fusion

BOUCHON FEMELLE
à souder

ENDKAPPE
Schweißmuffenanschluß
27.096.01

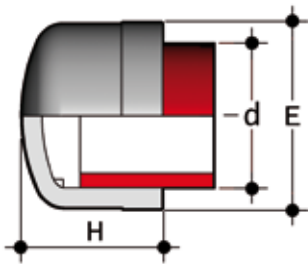

	d	E	H	g
	20	27,5	24,5	7
	25	33,5	27	11
	32	42	31,5	19
	40	51	35,5	31
	50	63	41	50
	63	77,5	44	88
	75	91	48	116
	90	109	65	212
	110	132	71	349

QHV-X / QHV-Y

GUARNIZIONE PIANA
in EPDM ed FPM per collari e flange

FLAT GASKET
in EPDM and FPM for stubflanges
and backing rings

JOINT PLAT
en EPDM et FPM pour collets et
brides

FLACHDICHTUNG
aus EPDM und FPM für Bundbuchsen
und Flansche

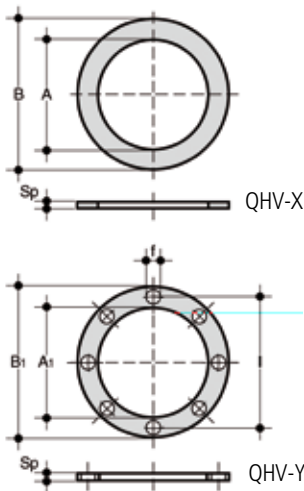

d	DN	*QHV-X					**QHV-Y				
		A	B	Sp	A ₁	B ₁	Sp ₁	f	I	U	
20	15	20	32	2	17	95	2	14	65	4	
25	20	24	38,5	2	22	107	2	14	76,3	4	
30	25	32	44	2	28	117	2	14	86,5	4	
40	32	40	59	2	36	142,5	2	18	101	4	
50	40	50	71	2	45	153,3	2	18	111	4	
63	50	63	88	2	57	168	2	18	125,5	4	
75	65	75	104	2	71	187,5	3	18	145,5	4	
90	80	90	123	2	84	203	3	18	160	8	
110	100	110	148	3	102	223	3	18	181	8	

* EPDM-FPM
** EPDM

ODB

FLANGIA LIBERA
in acciaio rivestito di PP
DIN 2501 - EN1092 - DIN 16962
/16963 per collare d'appoggio
QRNM

BACKING RING
PP with steel core
flange size: DIN 2501 - EN1092
DIN 16962/16963
for QRNM stub flange

BRIDE LIBRE
PP avec âme en acier
dimension de bride: DIN 2501 -
EN1092 - DIN 16962/16963
pour collets QRNM

LOSFLANSCH
PP mit Stahleinlage
Flanschanschlußmaß: DIN 2501 -
EN1092 - DIN 16962/16963
für Bundbuchse QRNM

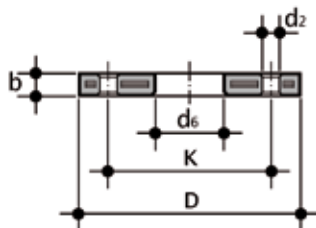

d	DN	*PMA [bar]	b	k	d ₂	d ₆	D	n	M	**[Nm]	g
20	15	16	12	65	14	28	95	4	M12	15	290
25	20	16	14	75	14	34	105	4	M12	15	410
32	25	16	16	85	14	42	115	4	M12	15	610
40	32	16	16	100	18	51	140	4	M16	20	880
50	40	16	16	110	18	62	150	4	M16	30	810
63	50	16	19	125	18	78	165	4	M16	35	940
75	65	16	19	145	18	92	185	4	M16	40	1210
90	80	16	21	160	18	109	200	8	M16	40	1480
125	100	16	20	180	18	134	220	8	M16	45	1570

OAB

FLANGIA LIBERA
in acciaio rivestito di PP
ANSI 150 per collari QRNM-QRAM

BACKING RING
PP with steel core flange size:
ANSI 150
for QRNM-QRAM stub flange

BRIDE LIBRE
PP avec âme en acier dimension de
bride: ANSI 150
pour collets QRNM-QRAM

LOSFLANSCH
PP mit Stahleinlage Flanschschlußmaß:
ANSI 150
für Bundbuchse QRNM-QRAM

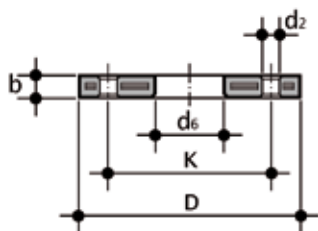

d	DN	*PMA	b	k	d ₂	d ₆	D	n	**[Nm]	g		
mm	inch	[bar]		mm	inch	mm						
20	1/2"	16	12	60,45	2 3/8"	16	5/8"	28	95	4	15	220
25	3/4"	16	12	69,85	2 3/4"	16	5/8"	34	102	4	15	240
32	1"	16	16	79,25	3 1/8"	16	5/8"	42	114	4	15	390
40	1 1/4"	16	16	88,9	3 1/2"	16	5/8"	51	130	4	25	510
50	1 1/2"	16	18	98,55	3 7/8"	16	5/8"	62	133	4	35	580
63	2"	16	18	120,65	4 3/4"	20	3/4"	78	162	4	35	860
75	2 1/2"	16	18	139,7	5 1/2"	20	3/4"	92	184	4	40	1100
90	3"	16	18	152,4	6"	20	3/4"	111	194	4	40	1040
110	4"	16	18	190,5	7 1/2"	20	3/4"	133	229	8	40	1620

ODBC

FLANGIA CIECA
in acciaio rivestito di PP DIN 2501 -
EN1092 - DIN 16962/16963

BLINDFLANGE
PP with steel core
flange size: DIN 2501 - EN1092
DIN 16962/16963

BRIDE FOLLE
PP avec âme en acier
dimension de bride: DIN 2501 -
EN1092 - DIN 16962/16963

BLINDFLANSCH
PP mit Stahleinlage
Flanschschlußmaß: DIN 2501 -
EN1092 - DIN 16962/16963

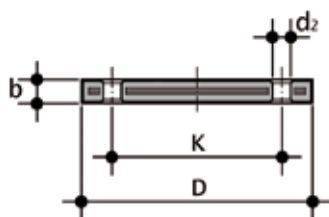

d	DN	*PMA	b	k	d ₂	D	n	M	**[Nm]	g
mm		[bar]								
20	15	16	12	65	14	95	4	M12	15	290
25	20	16	12	75	14	105	4	M12	15	390
32	25	16	16	85	14	115	4	M12	15	550
40	32	16	16	100	18	140	4	M16	25	820
50	40	16	16	110	18	150	4	M16	35	900
63	50	16	16	125	18	165	4	M16	35	1150
75	65	16	18	145	18	185	4	M16	40	1680
90	80	16	18	160	18	200	8	M16	40	2240
110	100	16	20	180	18	220	8	M16	45	2800

Valori di massima pressione in accordo
a DIN 16962/5. Porre attenzione ai
valori di massima pressione ammissibile
per le guarnizioni usate

Pressure rating values according to
DIN 16962/5.
Pay attention to the admissible pressu-
res for the used sealings

Pression suivant DIN 16962/5.
Attention à la pression maximale des
joints plats

Zulässiger Betriebsdruck gemaess
DIN 16962/5.
Zulässige Drücke für die verwendeten
Dichtungen beachten

* PMA: pressione di esercizio massi-
ma ammissibile

* PMA: allowable maximum opera-
ting pressure

* PMA: pression maximale admis-
sible

* PMA: Höchster zulässiger
Bauteilbetriebrdruck

** Momento di serraggio nominale

** Nominal torque required to
tighten bolts

** Couple de serrage nominale des
boulons

** Richtwerte für das
Anzugsdrehmoment bei flansch-
verbindungen

Code

AIM pag. 26

d	Code
20 x 22 x 20	AIM020022020
25 x 27 x 25	AIM025027025
32 x 32 x 30	AIM032032030
40 x 42 x 40	AIM040042040
50 x 52 x 50	AIM050052050
63 x 64 x 60	AIM063064060

BIRMO pag. 25

d x R	Code
20 x 1/2"	BIRMO020012E
25 x 3/4"	BIRMO025034E
32 x 1"	BIRMO032100E
40 x 1 1/4"	BIRMO040114E
50 x 1 1/2"	BIRMO050112E
63 x 2"	BIRMO063200E

BIFM pag. 24

d x R	EPDM	FPM
20 x 1/2"	BIFM020012E	BIFM020012F
25 x 3/4"	BIFM025034E	BIFM025034F
32 x 1"	BIFM032100E	BIFM032100F
40 x 1 1/4"	BIFM040114E	BIFM040114F
50 x 1 1/2"	BIFM050112E	BIFM050112F
63 x 2"	BIFM063200E	BIFM063200F

CIM pag. 28

d	Code
20	CIM020
25	CIM025
32	CIM032
40	CIM040
50	CIM050
63	CIM063
75	CIM075
90	CIM090
110	CIM110

BIFMO pag. 24

d x R	Code
20 x 1/2"	BIFMO020012E
25 x 3/4"	BIFMO025034E
32 x 1"	BIFMO032100E
40 x 1 1/4"	BIFMO040114E
50 x 1 1/2"	BIFMO050112E
63 x 2"	BIFMO063200E

EFMG pag. 26

d x R	Code
20 x 1"	EFMG100
25 x 1 1/4"	EFMG114
32 x 1 1/2"	EFMG112
40 x 2"	EFMG200
50 x 2 1/4"	EFMG214
63 x 2 3/4"	EFMG234

BIM pag. 24

d	EPDM	FPM
20	BIM020E	BIM020F
25	BIM025E	BIM025F
32	BIM032E	BIM032F
40	BIM040E	BIM040F
50	BIM050E	BIM050F
63	BIM063E	BIM063F

GIM pag. 22

d	Code
20	GIM020
25	GIM025
32	GIM032
40	GIM040
50	GIM050
63	GIM063
75	GIM075
90	GIM090
110	GIM110

BIMG pag. 25

d	EPDM	FPM
20	BIMG020E	BIMG020F
25	BIMG025E	BIMG025F
32	BIMG032E	BIMG032F
40	BIMG040E	BIMG040F
50	BIMG050E	BIMG050F
63	BIMG063E	BIMG063F

Code

HIM pag. 23

d	Code
20	HIM020
25	HIM025
32	HIM032
40	HIM040
50	HIM050
63	HIM063
75	HIM075
90	HIM090
110	HIM110

MIM pag. 26

d	Code
20	MIM020
25	MIM025
32	MIM032
40	MIM040
50	MIM050
63	MIM063
75	MIM075
90	MIM090
110	MIM110

MIMM pag. 27

d x R	Code
20 x 1/2"	MIMM020012
25 x 3/4"	MIMM025034
32 x 1"	MIMM032100
40 x 1 1/4"	MIMM040114
50 x 1 1/2"	MIMM050112
63 x 2"	MIMM063200

OAB pag. 29

DN	Code
1/2"	OAB012
3/4"	OAB034
1"	OAB100
1 1/4"	OAB114
1 1/2"	OAB112
2"	OAB200
2 1/2"	OAB212
3"	OAB300
4"	OAB400
6"	OAB600
8"	OAB800
10"	OAB810
12"	OAB812

ODB pag. 28

d	Code
20	ODB020
25	ODB025
32	ODB032
40	ODB040
50	ODB050
63	ODB063
75	ODB075
90	ODB090
110	ODB110
125	ODB125
140	ODB140
160	ODB160
180	ODB180
200	ODB200
225	ODB225
250	ODB250
280	ODB280
315	ODB315
355	ODB355
400	ODB400

ODBC pag. 29

d	Code
20	ODBC020
25	ODBC025
32	ODBC032
40	ODBC040
50	ODBC050
63	ODBC063
75	ODBC075
90	ODBC090
110/125	ODBC110
140	ODBC140
160/180	ODBC160
200/225	ODBC200
250/280	ODBC250
315	ODBC315
355	ODBC355
400	ODBC400

Q/BIMG pag. 25

d	Code
20	QBIMG020
25	QBIMG025
32	QBIMG032
40	QBIMG040
50	QBIMG050
63	QBIMG063

Code

QHV/X pag. 28

d	EPDM	FPM
20	QHVX020E	QHVX020F
25	QHVX025E	QHVX025F
32	QHVX032E	QHVX032F
40	QHVX040E	QHVX040F
50	QHVX050E	QHVX050F
63	QHVX063E	QHVX063F
75	QHVX075E	QHVX075F
90	QHVX090E	QHVX090F
110	QHVX110E	QHVX110F
160	QHVX160E	QHVX160F

QHV/Y pag. 28

d	EPDM
20	QHVV020E
25	QHVV025E
32	QHVV032E
40	QHVV040E
50	QHVV050E
63	QHVV063E
75	QHVV075E
90	QHVV090E
110	QHVV110E
160	QHVV160E

GRAM pag. 27

d	Code
3/4"	GRAM034
1"	GRAM100
1 1/4"	GRAM114
1 1/2"	GRAM112
3"	GRAM300

QRNM pag. 27

d	Code
20	QRNM020
25	QRNM025
32	QRNM032
40	QRNM040
50	QRNM050
63	QRNM063
75	QRNM075
90	QRNM090
110	QRNM110

RIM pag. 23

d x d1	Code
25 x 20	RIM025020
32 x 20	RIM032020
32x 25	RIM032025
40 x 25	RIM040025
40 x 32	RIM040032
50 x 32	RIM050032
50 x 40	RIM050040
63 x 32	RIM063032
63 x 50	RIM063050
75 x 50	RIM075050
75 x 63	RIM075063
90 x 63	RIM090063
90 x 75	RIM090075
110 x 63	RIM110063
110 x 90	RIM110090

TIM pag. 23

d	Code
20	TIM020
25	TIM025
32	TIM032
40	TIM040
50	TIM050
63	TIM063
75	TIM075
90	TIM090
110	TIM110